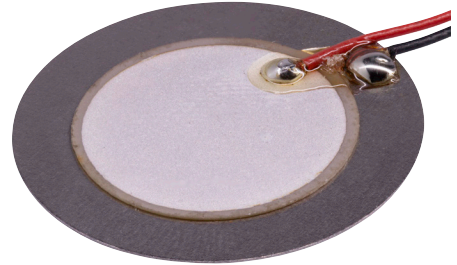

**MODEL:** CEB-2043-L100 | **DESCRIPTION:** PIEZOELECTRIC DIAPHRAGM

**FEATURES**

- 100 mm lead wire
- piezo element
- externally driven

**SPECIFICATIONS**

parameter	conditions/description	min	typ	max	units
operating voltage				30	Vp-p
resonant frequency	only for piezo element without wire	6,900	7,200	7,500	Hz
resonant impedance	only for piezo element without wire			300	$\Omega$
electrostatic capacity	at 120 Hz	7,000	10,000	13,000	pF
dimensions	$\varnothing 20 \times 0.43$				mm
weight			2.5		g
material	stainless steel				
terminal	wire leads				
operating temperature		-20		60	$^{\circ}\text{C}$
storage temperature		-30		70	$^{\circ}\text{C}$
hand soldering		370	380	390	$^{\circ}\text{C}$
RoHS	yes				

**MECHANICAL DRAWING**

units: mm

tolerance:  $\pm 0.5$  mm

wire: UL1571, 32 AWG

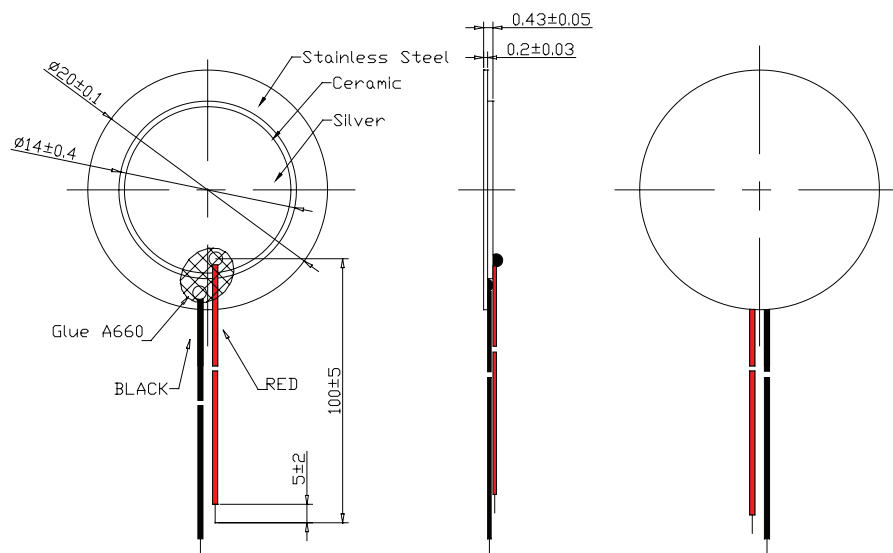

## REVISION HISTORY

rev.	description	date
1.0	initial release	05/13/2024

The revision history provided is for informational purposes only and is believed to be accurate.



CUI Devices offers a one (1) year limited warranty. Complete warranty information is listed on our website.

CUI Devices reserves the right to make changes to the product at any time without notice. Information provided by CUI Devices is believed to be accurate and reliable. However, no responsibility is assumed by CUI Devices for its use, nor for any infringements of patents or other rights of third parties which may result from its use.

CUI Devices products are not authorized or warranted for use as critical components in equipment that requires an extremely high level of reliability. A critical component is any component of a life support device or system whose failure to perform can be reasonably expected to cause the failure of the life support device or system, or to affect its safety or effectiveness.

[cuidevices.com](http://cuidevices.com)