

MODEL: CEB-1220 | **DESCRIPTION:** PIEZOELECTRIC DIAPHRAGM

FEATURES

- piezo element
- externally driven

SPECIFICATIONS

parameter	conditions/description	min	typ	max	units
operating voltage				30	Vp-p
resonant frequency		7,500	8,500	9,500	Hz
resonant impedance				300	Ω
electrostatic capacity	at 100 Hz	9,100	13,000	16,900	pF
dimensions	$\varnothing 12 \times 0.20$				mm
weight			0.3		g
material	brass				
operating temperature		-20		60	$^{\circ}\text{C}$
storage temperature		-20		70	$^{\circ}\text{C}$
hand soldering	brass	340	360	380	$^{\circ}\text{C}$
	silver	260	280	300	$^{\circ}\text{C}$
RoHS	yes				

MECHANICAL DRAWING

units: mm
tolerance: ± 0.5 mm

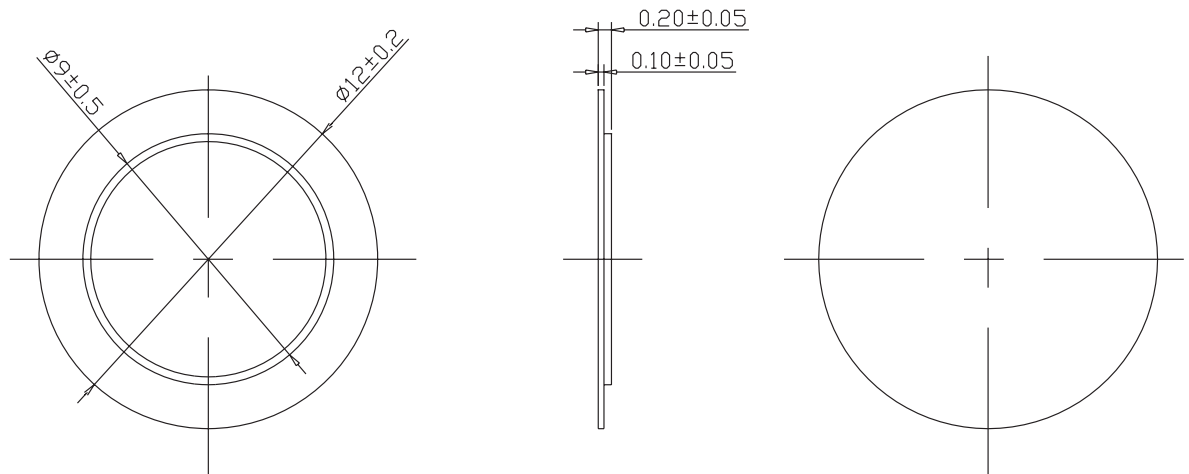

REVISION HISTORY

rev.	description	date
1.0	initial release	05/14/2024

The revision history provided is for informational purposes only and is believed to be accurate.



CUI Devices offers a one (1) year limited warranty. Complete warranty information is listed on our website.

CUI Devices reserves the right to make changes to the product at any time without notice. Information provided by CUI Devices is believed to be accurate and reliable. However, no responsibility is assumed by CUI Devices for its use, nor for any infringements of patents or other rights of third parties which may result from its use.

CUI Devices products are not authorized or warranted for use as critical components in equipment that requires an extremely high level of reliability. A critical component is any component of a life support device or system whose failure to perform can be reasonably expected to cause the failure of the life support device or system, or to affect its safety or effectiveness.

cuidevices.com